



ProWood® Project Plan

OUTDOOR STORAGE BOX

Purchased Materials:

- (13) 2" x 2" x 8' ProWood® ground-contact rated lumber
- (9) 1" x 6" x 12' ProWood® ground-contact rated lumber
- (1) Box of #8 x 2" exterior wood screws
- (1) Box of #8 x 2-1/2" exterior wood screws
- (1) 48" Continuous Hinge

Optional:

- (1) 55 Gallon Tote (for weatherproofing)
- (1) 24" chain/rope (for box lid)
- Water sealer
- Exterior stain, black (for interior frame)

Basic Tools:

- Tape measure
- Carpenter's square
- Circular or table saw
- 3/16" drill bit (for pre-drilling)
- Power drill with screw driving bit

Optional:

- Impact driver
- Sander or sandpaper (for removing ink stamps on lumber)
- Pocket hole jig (for predrilling interior frame)
- Orbital sander, planer or table router (for beveled board edges)



If your wood project touches or comes near the ground, use pressure-treated lumber that is rated for ground contact to ensure long-term performance.

Cut Wood to Size

Caution: Always wear gloves, a dust mask and eye protection when sawing, sanding or machining wood. Always use a circular, miter saw or table saw on a clean, flat and level surface.

We recommend only cutting lumber for each sections as you assemble. To save on material, measure and cut previously cut lumber rather than continually cutting from a new board. Lumber has both nominal and actual dimensions, meaning your 2" x 2" post or 1" x 6" board may actually be a slightly different size.

General Assembly Tips

- Establish a screw pattern to enhance the overall look and feel of the final assembled product.
- Pre-drill all screw holes with a drill bit to ease screw insertion and prevent wood splitting.
- Countersink all screws so the head of a countersunk screw, when placed in the hole, will sit flush with the surface of the surrounding material.

ITEM NO.	NAME	QTY.	DESCRIPTION
A	Frame - Side Rails	4	1-1/2" x 1-1/2" x 28"
B	Frame - Vertical Support Rails	16	1-1/2" x 1-1/2" x 20"
C	Side Board	8	3/4" x 5-1/2" x 29-1/2"
D	Frame - Front/Back Top Rails	4	1-1/2" x 1-1/2" x 48"
E	Front/Back Board	7	3/4" x 5-1/2" x 50"
F	Hinge Detail Board	1	3/4" x 4-3/4" x 50"
G	Floor Board	4	3/4" x 5-1/2" x 48"
H	Frame - Cross Support Rails	10	1-1/2" x 1-1/2" x 25"
I	Frame - Top Outer Rails	2	1-1/2" x 1-1/2" x 51"
J	Top Board	5	3/4" x 5-1/2" x 52-1/2"
K	Continuous Hinge	1	Continuous Hinge - 48"
L	55 gal Tote	1	55 Gallon Tote
M	Fastener	-	Exterior Wood Screw - 2"
N	Fastener	-	Exterior Wood Screw 2-1/2"
O	Chain	1	24"

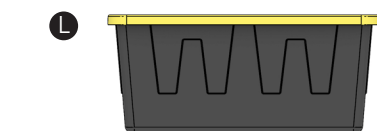
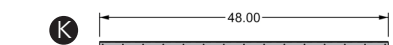
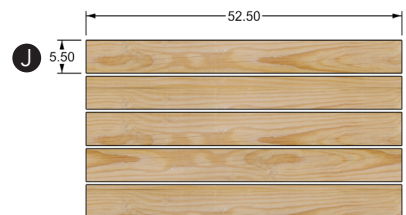
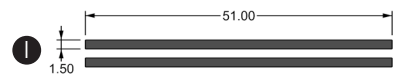
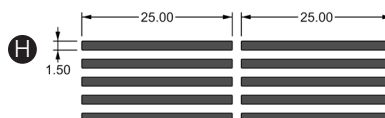
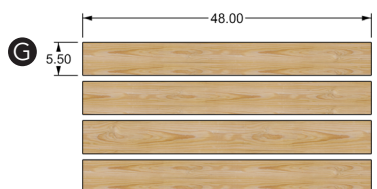
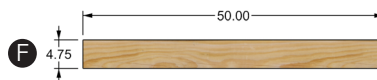
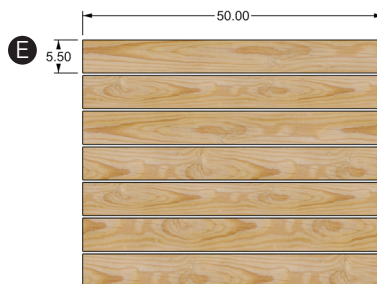
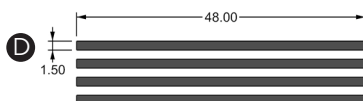
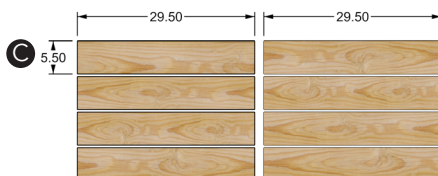
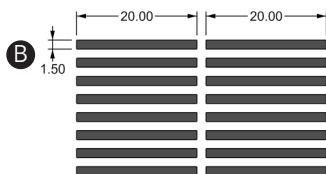
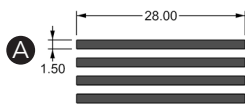

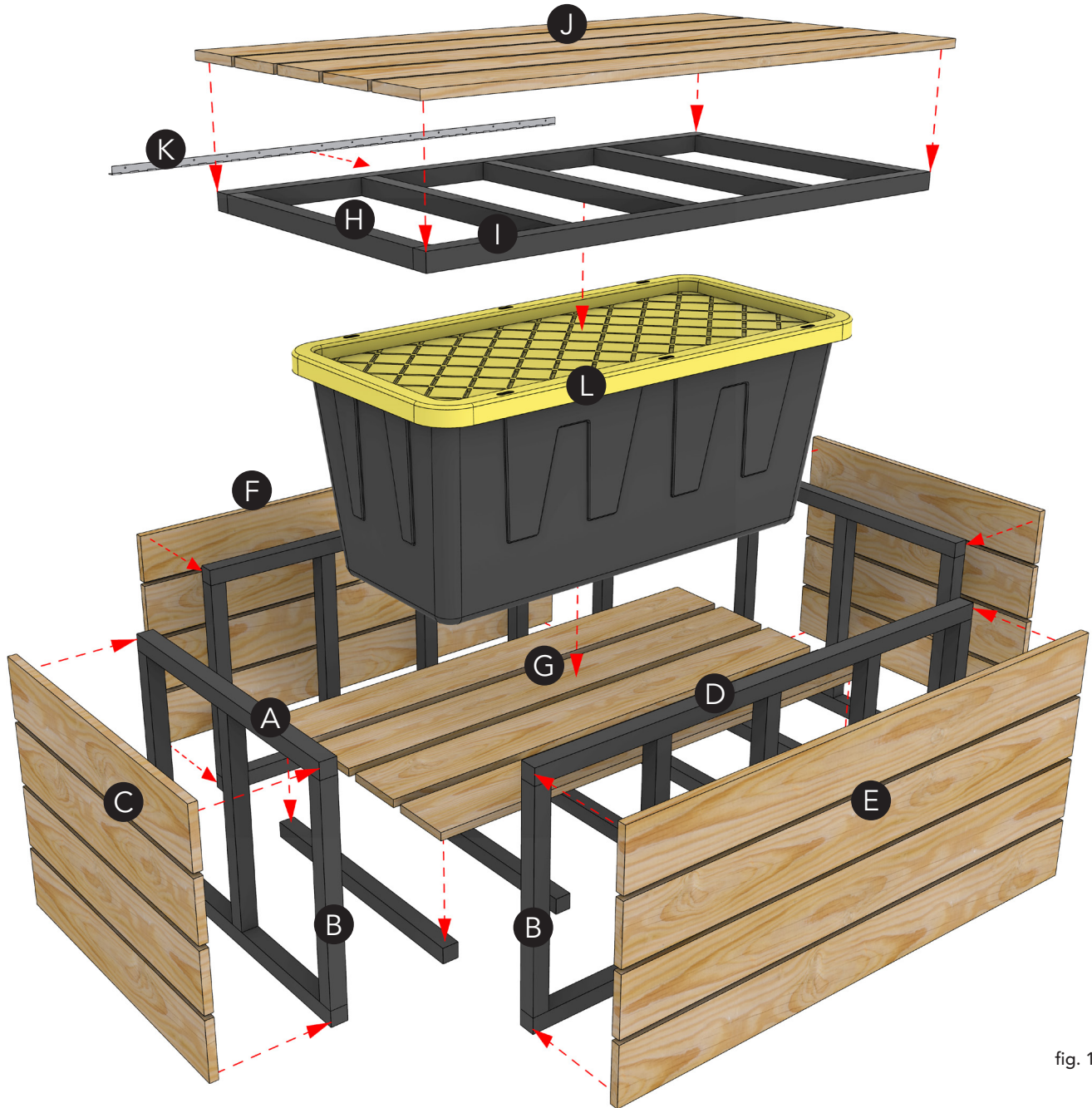
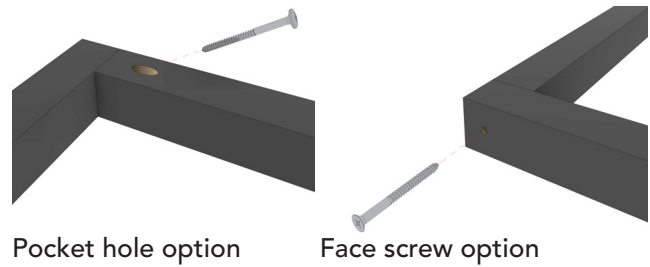

fig. 1

For detailed dimensions, refer to pages 9 and 10.

If desired, you may also stain your 2"x2" rails prior to installation for a clean look, both inside and out.

Optional fastener methods:



STEP 1

Assemble Box Sides
See fig. 2 and fig. 11

- Predrill and fasten the three (B) vertical support rails to the two (A) top rails using (M) fasteners.
- Space your top and bottom (C) boards with your bottom (C) board inset 1/2" and your top (C) board offset 3/4". Predrill the (A) top rails and (B) side rails and fasten the (C) boards using (M) fasteners.
- Equally space the inner (C) boards between the top and bottom boards and fasten with (M) fasteners.
- Repeat for the other box side.

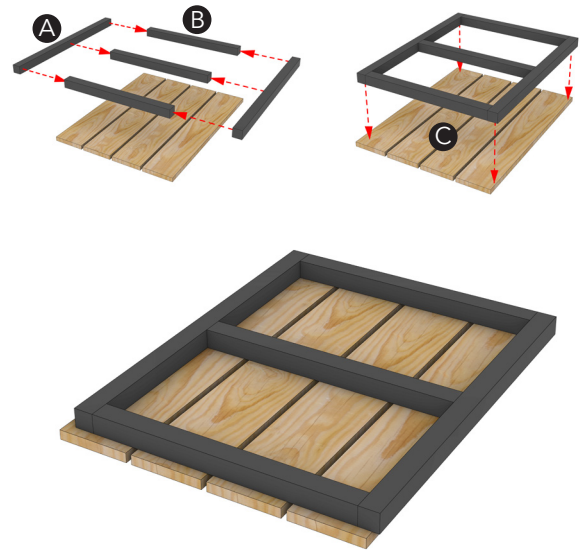

fig. 2

STEP 2

Assemble Box Front and Back
See fig. 3 and fig. 12

- Predrill and fasten the five (B) vertical support rails to the two (D) top rails using (M) fasteners.
- Space your top and bottom (E) boards, with your bottom (E) boards inset 1/2" and your top (E) boards offset 3/4". Predrill the (D) top rails and (B) vertical support rails and fasten the top and bottom (E) boards using (M) fasteners.
- Equally space the inner-two (E) boards between the top and bottom (E) board. Predrill the (B) rails and fasten using (M) fasteners.
- **Note:** When assembling box back, ensure top (F) board is flush with top (D) rail.

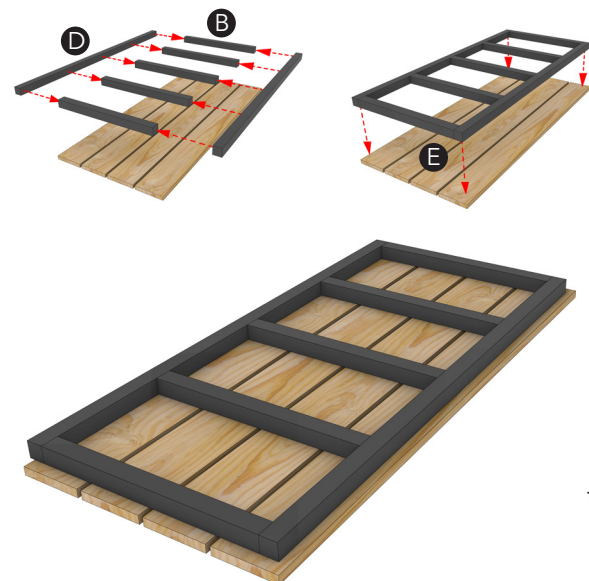

fig. 3

STEP 3

Fasten All Sides

See fig. 4

- Position the four assembled sides; the outer side of the front and back panel (B) vertical support rails should touch the front of the side (B) vertical support rails. Pre-drill and fasten the four sides using (N) fasteners.
- Using a carpenter's square, ensure all four sides meet at a 90° angle. Adjust as needed.

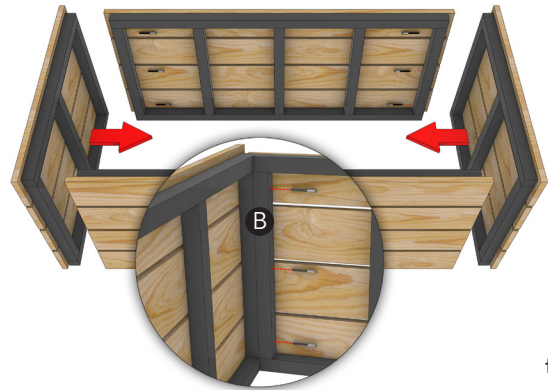

fig. 4

STEP 4

Install Bottom Cross-Support Rails

See fig. 5 and fig. 13

- Pre-drill the five (H) cross-support rails using a pocket hole jig. If a pocket hole jig is not available, pre-drill at a 45° angle.
- Position the (H) cross-support rails in between the two bottom (D) rails. Fasten using (M) fasteners.



fig. 5

STEP 5

Install Bottom Panels

See fig. 6 and fig. 13

- Evenly space each of the (G) floor boards on top of the (H) cross-support rails. Pre-drill and fasten each of the (G) floor boards using (M) fasteners.



fig. 7

STEP 6

Assemble Lid

See fig. 8 and fig. 14

- Predrill and fasten the (H) cross-support rails using to the (I) top outer rails using (M) fasteners.
- Place your two outer (J) boards 3/4" offset from the (I) top outer rails. Predrill your (I) rails and fasten using (M) fasteners.
- Equally space your three inner (J) boards in between the two fastened (J) boards. Predrill your (H) cross-support rails and fasten using (M) fasteners.
- Test fit assembled lid on top of assembled box. Make adjustments as needed.

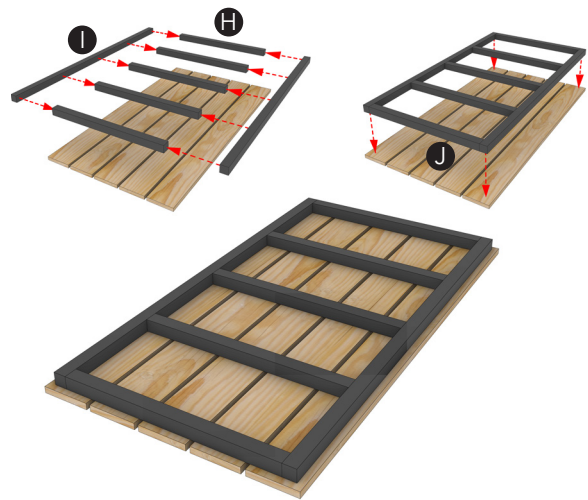

fig. 8

STEP 7

Attach Lid to Base

See fig. 9 and fig. 15

- Attach your (K) continuous hinge to your assembled lid using provided fasteners. Place and fasten to the box base.
- Attach the lid to the box using (K) continuous hinge.
- **Note:** When fastening (K) continuous hinge, ensure top (F) board is flush with top (D) rail.

Optional:

- You may add (O) chain from the box base to assembled lid with two (M) fasteners. Attach the chain from (A) frame side rail and corresponding (H) frame cross-support rail.
- Insert (L) 55 gallon tote into box. There should be ample room on all sides to accommodate for opening and closing the tote without removing it from the box.

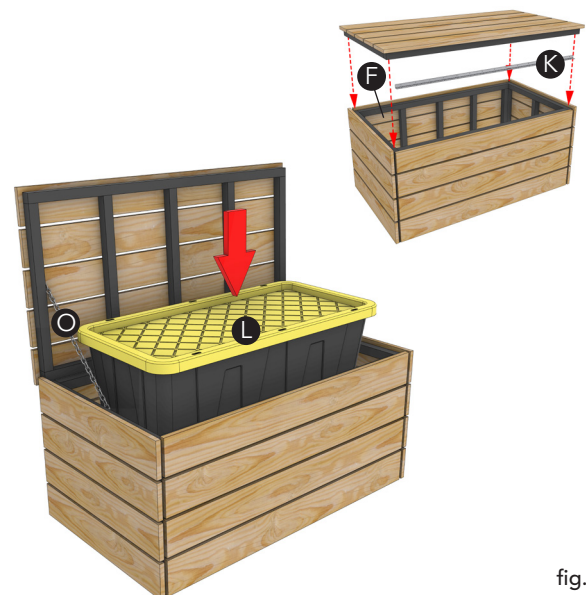

fig. 9

STEP 8

Cleanup and Disposal

See fig. 10 and fig. 16

- If desired, use a sander to remove any ink stamps from your lumber using sandpaper or a sander.
- Dispose of any unused lumber properly. Follow ProWood disposal guidelines.
- Apply a water sealer to your finished product once per year or as needed.



fig. 10



This document is for illustration purposes only. Use of this product must be in accordance with all local zoning and/or building codes. Consumer assumes all risks and liability associated with the use of this product. For details on safe handling, go to UFPI.com/ptinfo. Warrantor does not provide any warranty, either express or implied, and shall not be liable for any damages, including consequential damages. 7094 06/14

More plans available at www.prowoodlumber.com

ProWood is a registered trademark of UFP Industries Inc., in the U.S. ©2021 UFP Industries. All rights reserved.

STEP 1

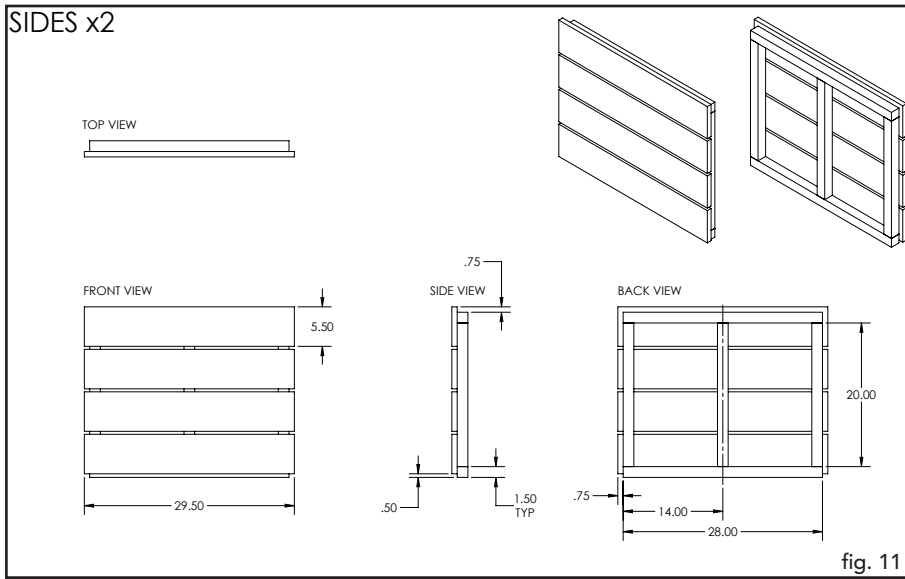

STEP 2

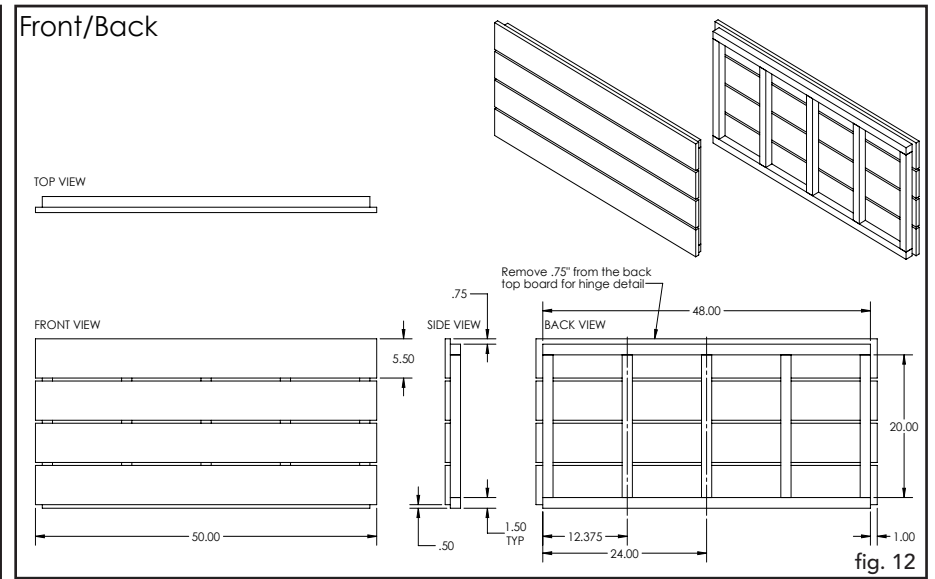

STEP 4 & 5

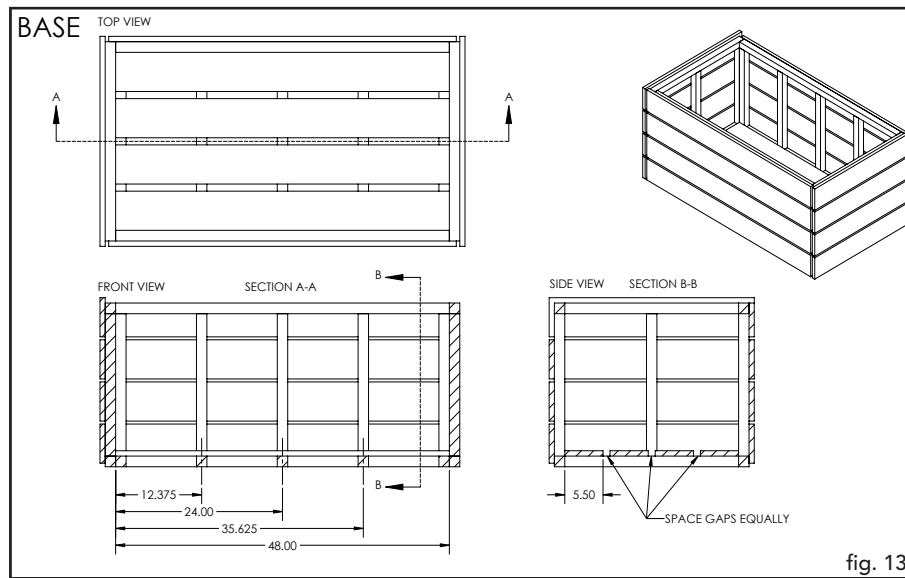

STEP 6

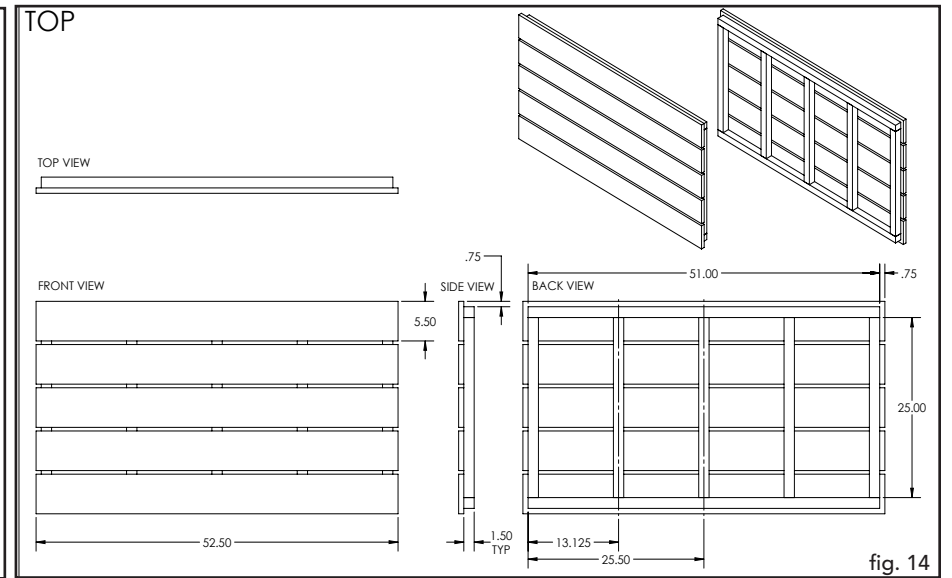

STEP 7

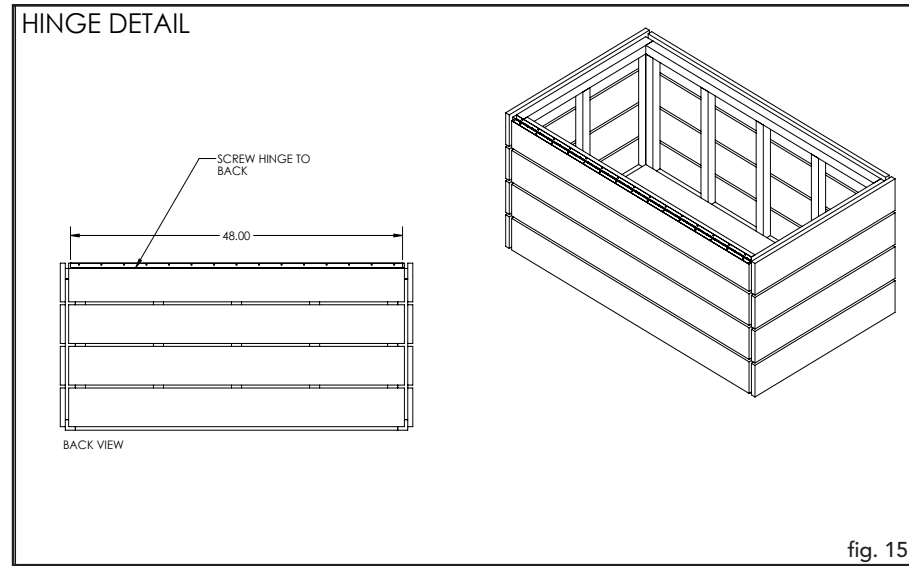

STEP 8

